

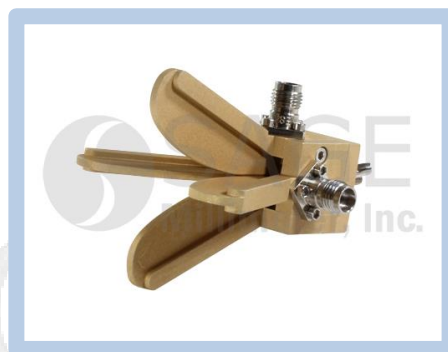

Quad-Ridged, Dual Polarized Horn Antenna, 5 to 50 GHz

Description:

Model SAV-0535031140-2F-U5-QR is a quad-ridged, dual polarized broadband horn antenna that operates from 5 to 50 GHz. The antenna offers a typical gain of 11 dBi and a typical 3 dB beamwidth of 40° on both the E-plane and H-plane, respectively. The antenna supports both linear and circular polarized waveforms. The antenna features a compact design and provides an M3 screw and a mounting plate for flexible mounting capacity. The RF ports are equipped with two female 2.4 mm connectors.



Features:

- Broadband Operation
- Coaxial Connector for RF Input
- Linear and Circular Polarization
- Good Impedance Match

Applications:

- Antenna Ranges
- Antenna Gain Measurements
- System Setups

Electrical Specifications:

Parameter	Minimum	Typical	Maximum
Frequency	5 GHz		50 GHz
Gain		11 dBi	
Polarization	Linear and Circular		
E-Plane 3 dB Beamwidth		40°	
H-Plane 3 dB Beamwidth		40°	
Port to Port Isolation	28 dB	30 dB	
E-Plane Sidelobe Levels		-10 dB	
H-Plane Sidelobe Levels		-15 dB	
Return Loss		10 dB	
Cross Polarization	18 dB	25 dB	
Power Handling			5 W (CW)
Specification Temperature		+25°C	
Operating Temperature	-40°C		+85°C

Mechanical Specifications:

Item	Specification
Antenna Ports	2.4 mm (F), 2.4 mm (F)
Mounting	M3 Screw and Mounting Plate
Material	Aluminum
Antenna Finish	Yellow Chem Film
Weight	1.3 Oz
Size	2.18" (L) X 1.76" (W) X 1.76" (H)
Outline	AV-C11-QR-RS1





Quad-Ridged, Dual Polarized Horn Antenna, 5 to 50 GHz

Typical Antenna Pattern @ 5 GHz

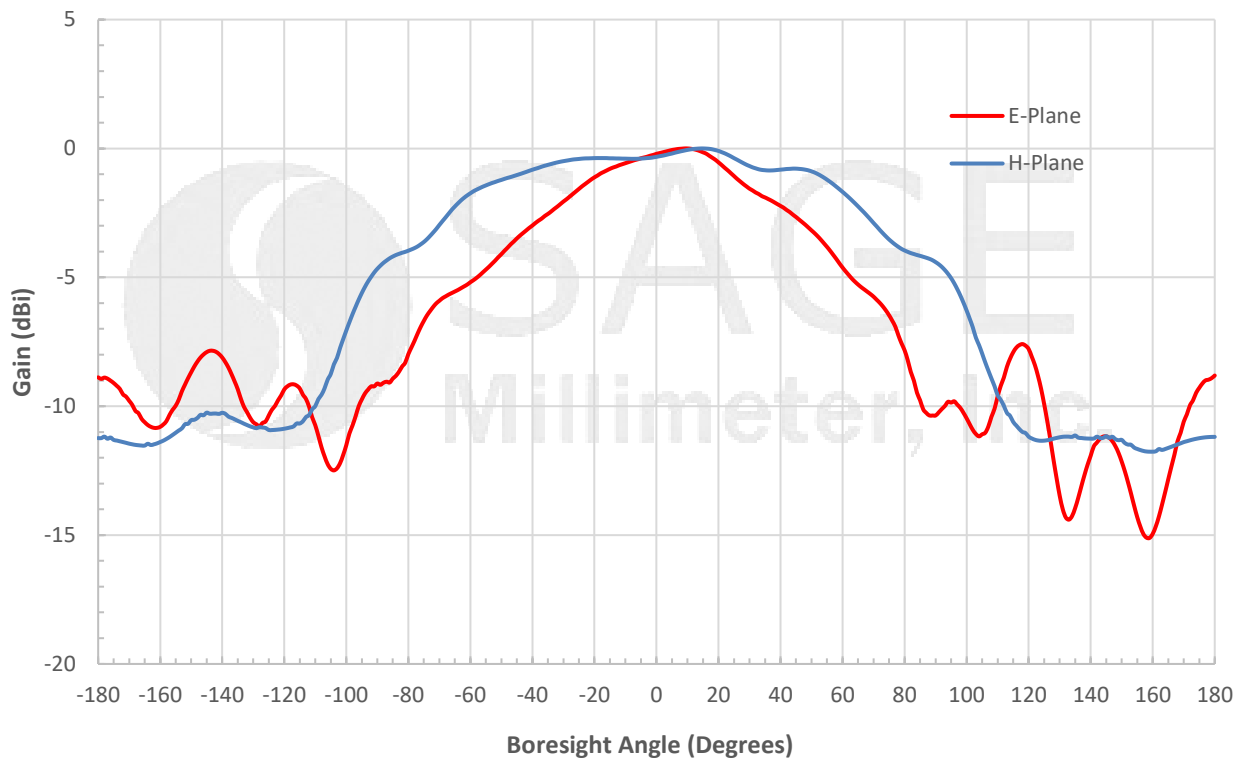

Typical Antenna Pattern @ 27.5 GHz

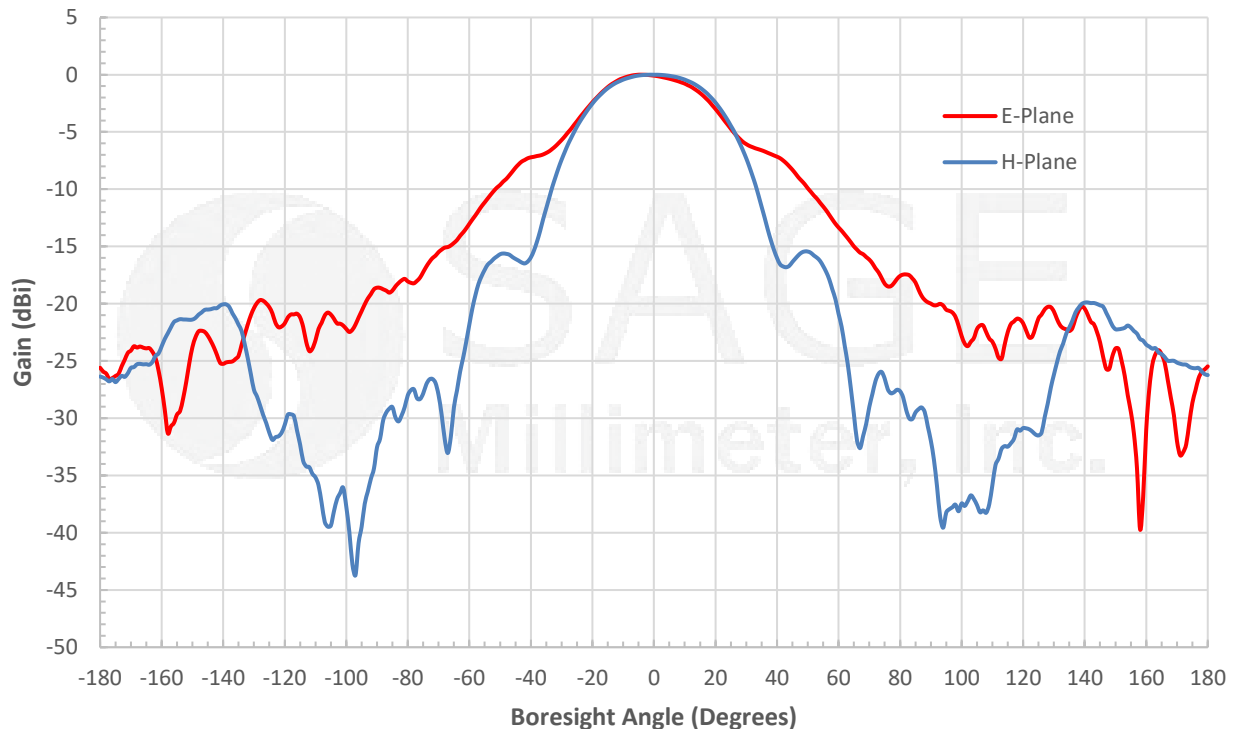



Quad-Ridged, Dual Polarized Horn Antenna, 5 to 50 GHz

Typical Antenna Pattern @ 50 GHz

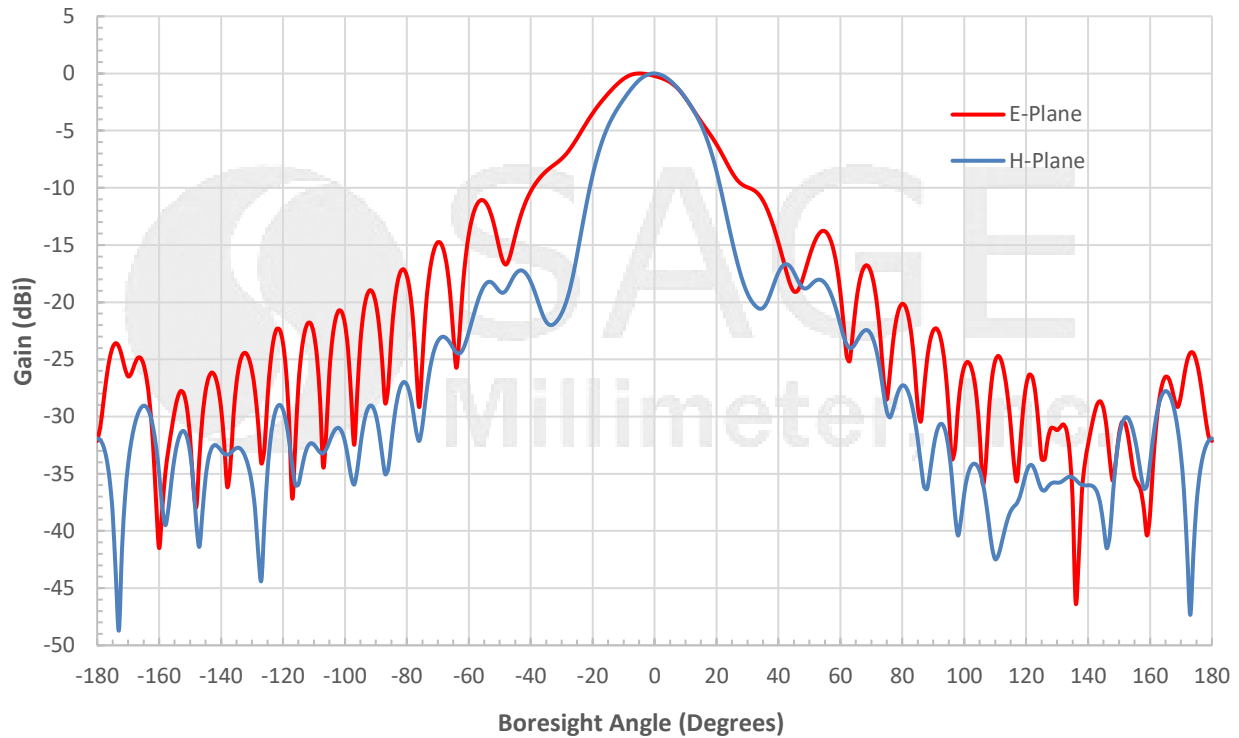

Typical Cross Polarization vs Frequency

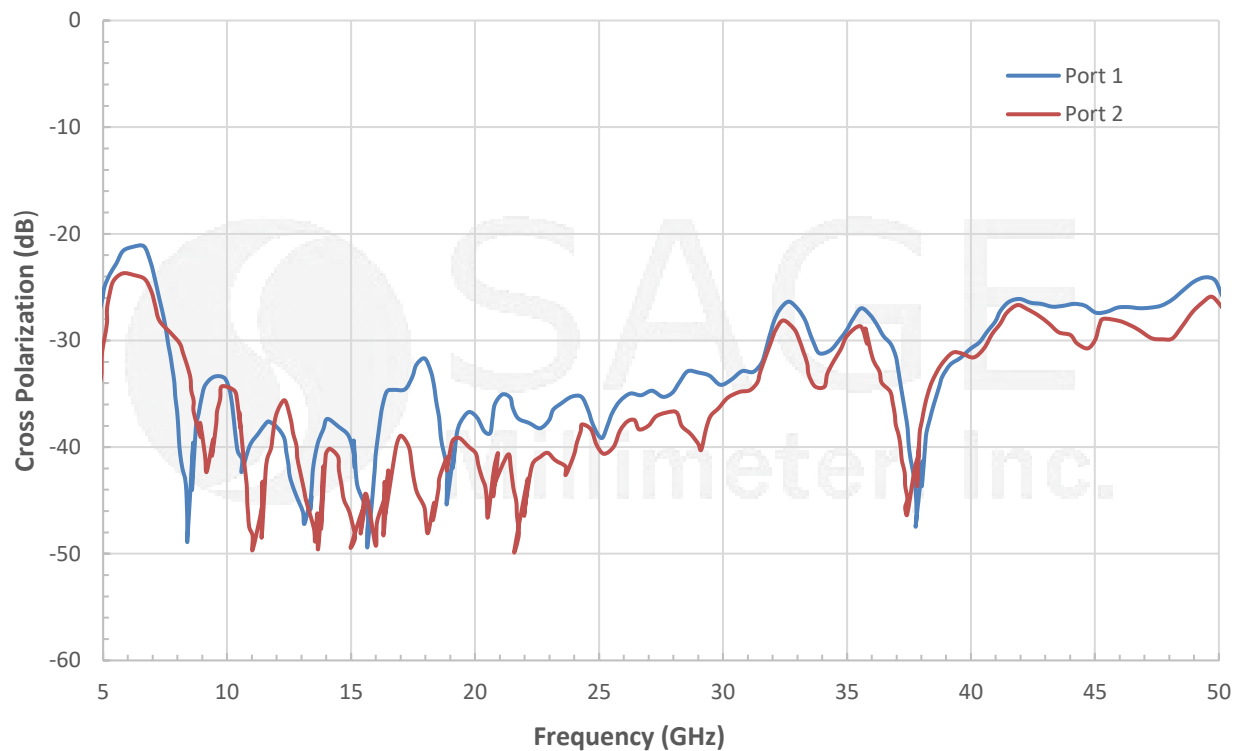



Quad-Ridged, Dual Polarized Horn Antenna, 5 to 50 GHz

Typical Gain vs. Frequency

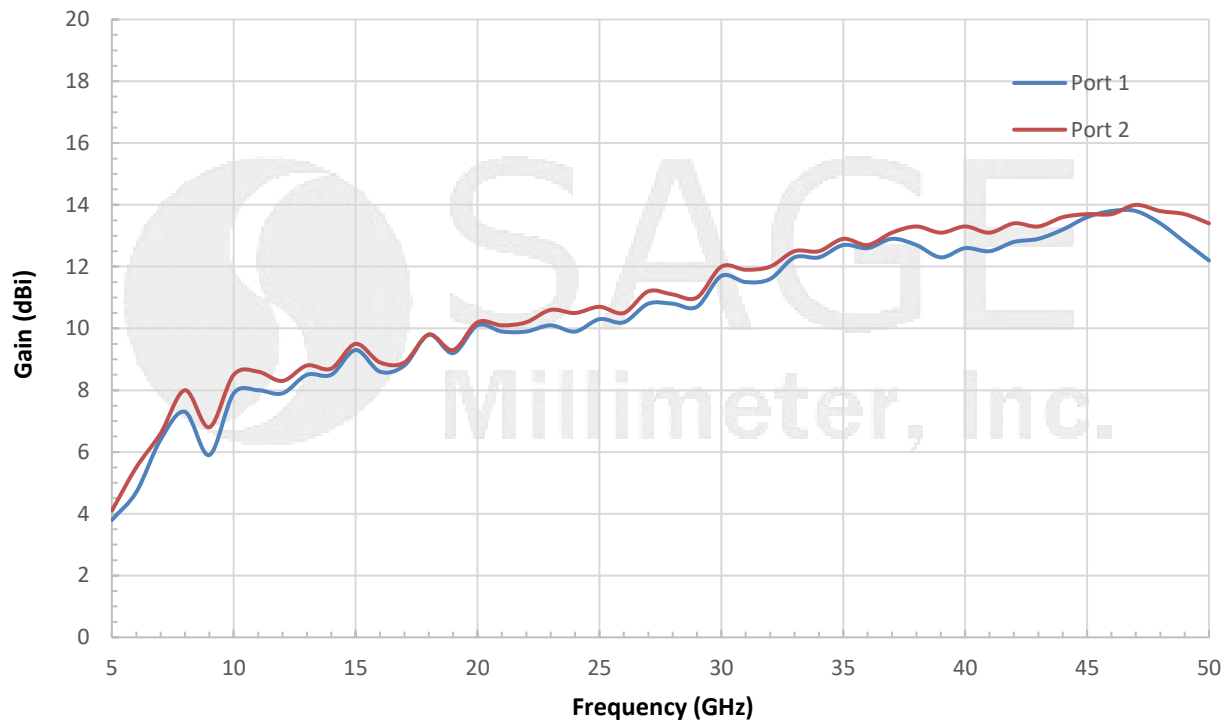

Typical 3 dB Beamwidth vs Frequency

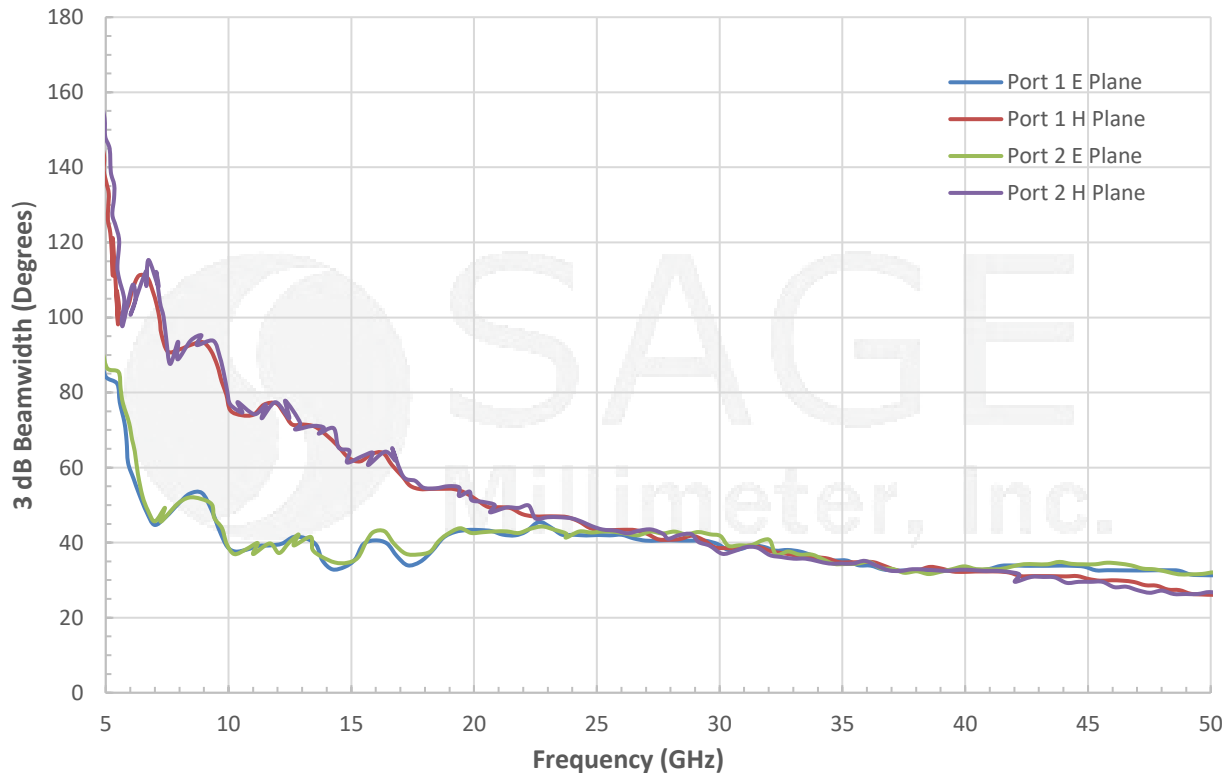



Quad-Ridged, Dual Polarized Horn Antenna, 5 to 50 GHz

Typical Port to Port Isolation vs. Frequency

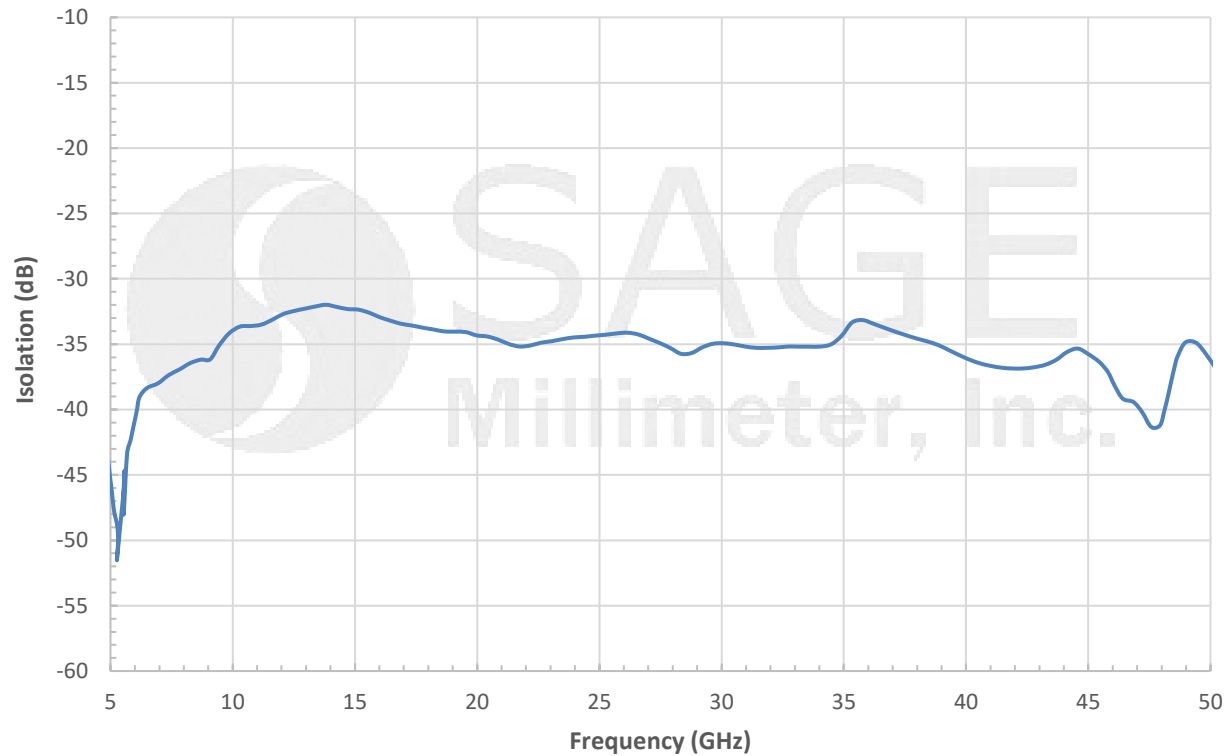

Typical Return Loss vs. Frequency

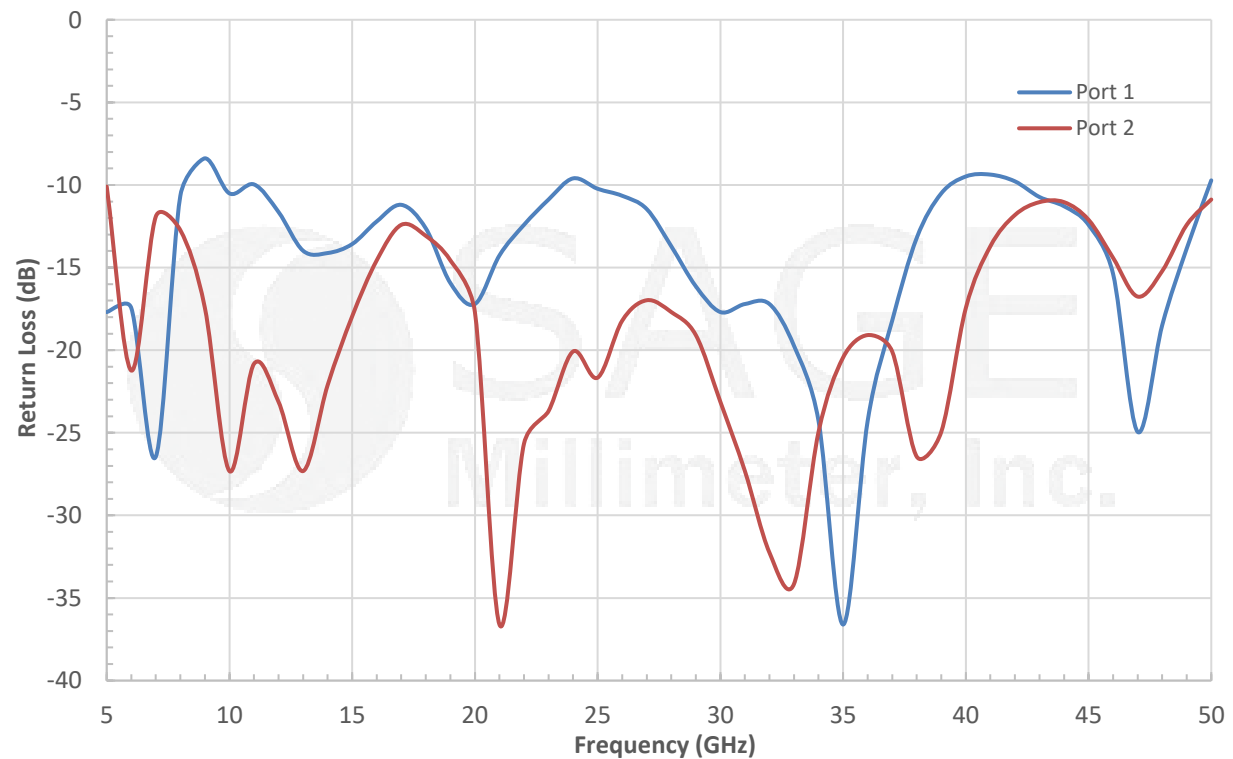



Quad-Ridged, Dual Polarized Horn Antenna, 5 to 50 GHz

Mechanical Outline: (Unless otherwise specified, all dimensions are in inches [millimeters])

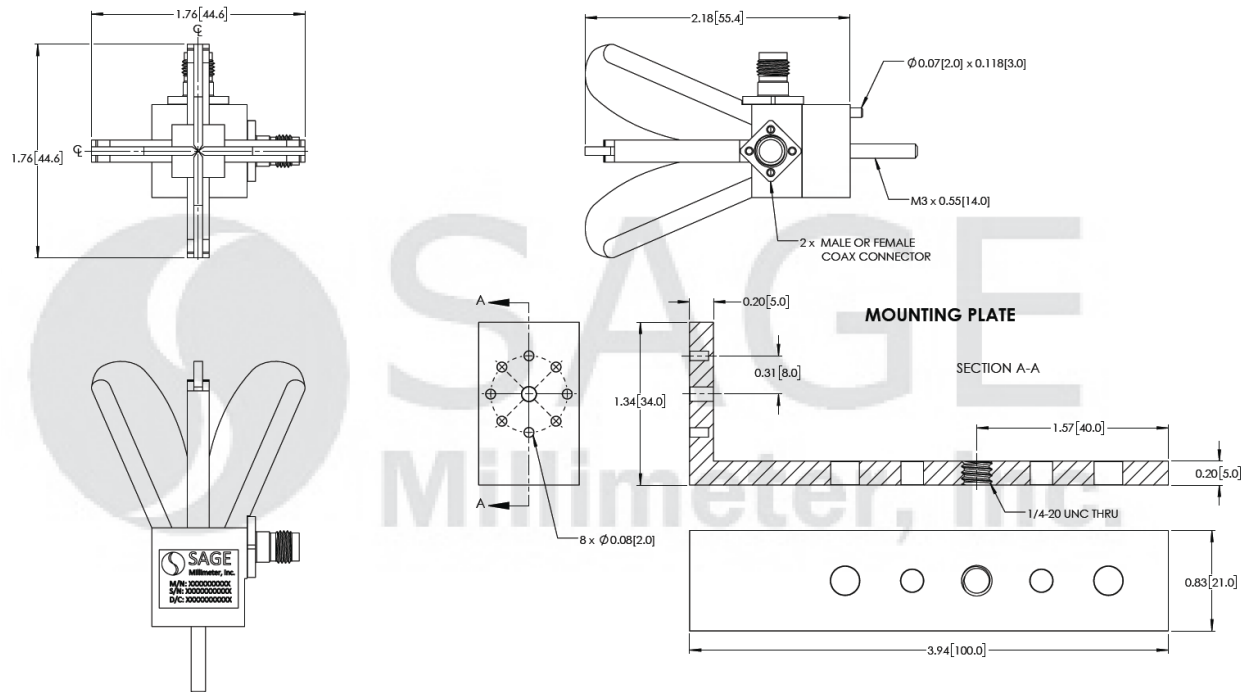

Note:

- All data presented is collected from a sample lot. Actual data may vary unit to unit.
- All testing was performed under +25 °C room temperature.
- SAGE Millimeter, Inc. reserves the right to change the information presented without notice.

Caution:

- Any foreign objects in the structure will cause performance degradation and possible device damage.
- Proper torque, 8.0 ± 0.15 inch-pounds (0.90 ± 0.02 Nm), should be applied. **SAGE Millimeter torque wrench, model SCH-08008-S1, is highly recommended.**

